

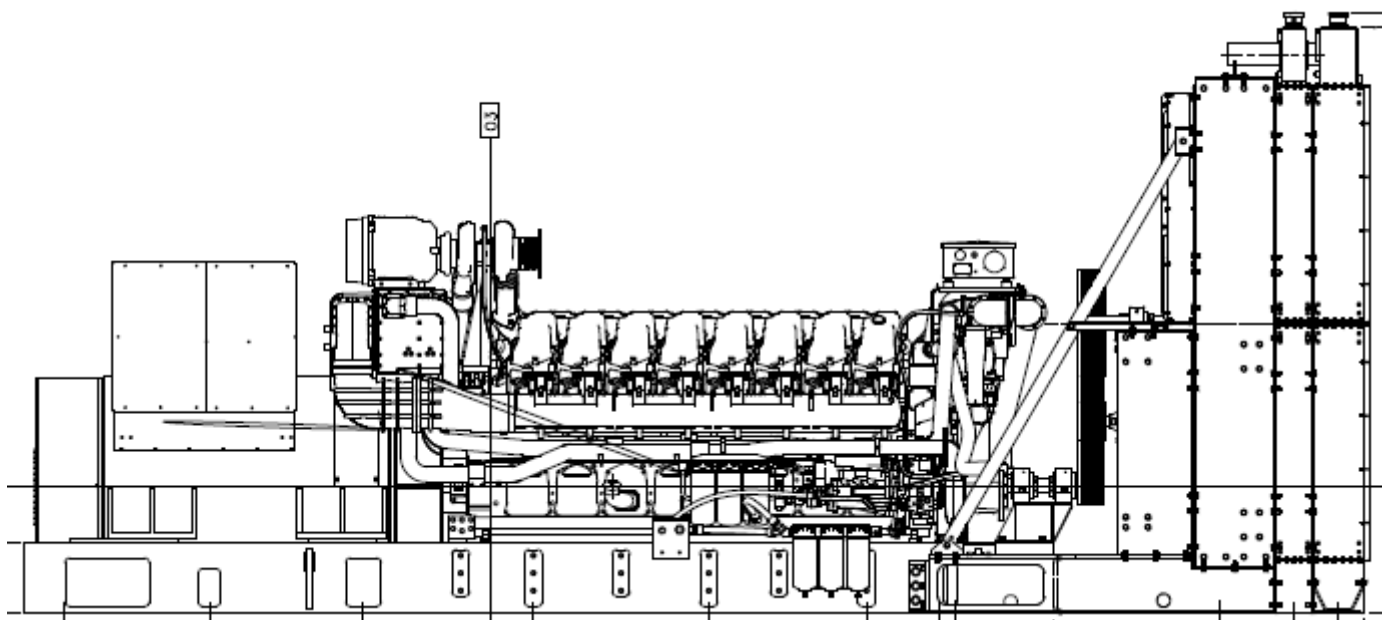

# INSTALLATION MANUAL FOR AUXILIARY DRIVE ON CATERPILLAR C175 Engines



9625 55<sup>TH</sup> Street  
Kenosha, WI 53144  
Telephone (262) 942-1414  
Fax (262) 942-1410  
Toll Free (800) 919-9559  
Website [www.iearad.com](http://www.iearad.com)  
Email [sales@iearad.com](mailto:sales@iearad.com)



# **Table of Contents**

Table of Contents .....	2
Table of Figures .....	2
Introduction .....	3
Primary Components of Drive System .....	3
Step 1: Gather all required resources.....	4
Step 2: Remove Jacket water (JW) and After cooler (AC) pump flanges and bypass tube off engine.....	4
Step 3: Remove damper cover from engine.....	5
Step 4: Remove paint from the ID of the damper bore and front face of the damper washer .....	5
Step 5: Lay auxiliary drive bracket on engine rails and mark holes .....	5
Step 6: Mount auxiliary drive bracket .....	6
Step 7: Install stub shaft onto damper .....	6
Step 8: Measure stub shaft run out with dial indicator.....	7
Step 9: Measure run out of front face of damper washer with dial indicator .....	8
Step 10: Mount coupling hub and taper lock bushing to stub shaft.....	9
Step 11: Set spacer plates and shims required.....	10
Step 12: Build auxiliary drive shaft assembly .....	11
Step 13: Lift auxiliary drive shaft assembly and place onto bracket.....	13
Step 14: Torque all set screws on thrust collars and bearings.....	13
Step 15: Measure dynamic run out of hubs.....	14
Step 16: Install radiator to engine rails .....	15
Step 17: Loosen idler and install belts.....	17
Step 18: Install coupling.....	17
Step 19: Tension drive belts .....	18
Step 20: Reinstall JW and AC pump flanges and bypass tube .....	18
Step 21: Belt guard and coupling guard installation .....	18
Step 22: Inspection required after moving engine and/or radiator .....	19

# **Table of Figures**

Figure 1: Front of C-175 Engine .....	5
Figure 2: Mounting auxiliary drive bracket.....	6
Figure 3: Bolt insertion and tightening order.....	6
Figure 4: Dial indicator on stub shaft.....	7
Figure 5: Dial indicator on front face of damper washer.....	8
Figure 6: Hub and taper lock bushing installed .....	9
Figure 7: Bearing shim selection and locations .....	10
Figure 8: Drive and bearing assembly diagram.....	12
Figure 9: Hub spacing.....	13
Figure 10: Dial indicator for hub run out .....	14
Figure 11: Dial indicator for hub run out .....	15
Figure 12: Engine rail to wishbone interface (outside view) .....	16
Figure 13: Engine rail to wishbone interface (inside view) .....	17
Figure 14: Flexible coupling installed .....	18
Figure 15: Guards and connection kit installed .....	19



## Introduction

Caterpillar C175 engines require an auxiliary drive to be installed between the engine and the radiator. This drive is CRITICAL and is best installed BEFORE moving the radiator to the engine.

**⚠ WARNING:** Failure to adhere to extreme tolerances listed in the manual will result in premature failure of the coupling. Coupling damage caused by incorrect installation is **not covered** by IEA warranty.

**📌 NOTE:** IEA, LLC recommends performing this at the ACTUAL use location. If the engine and/or radiator are moved for ANY reason (even if coupled), several steps MUST be completed again. Refer to Step 22.

## Primary Components of Drive System

While exact components of the drive system will vary by model number, all C-175 auxiliary drive systems require these components.

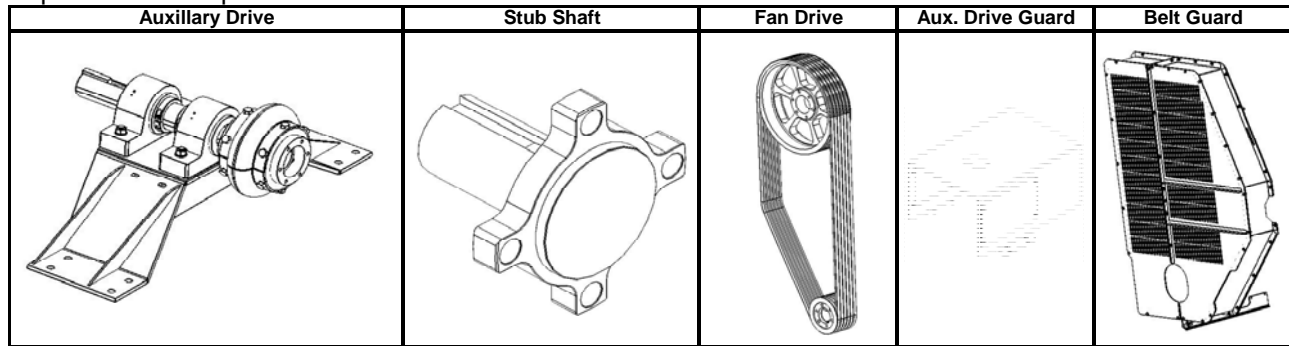

**Table 1: Primary Components of auxiliary drive systems**

Step	Action	Result
1	Gather all required resources	Confirm all items on hand for installation.
2	Remove engine JW, AC pump inlet flanges and bypass tube	Clear area for drilling mounting holes.
3	Remove damper cover from front of engine	Allows access to mount stub shaft.
4	Remove paint from ID of the damper bore and front face of the damper washer	Paint removed for smooth crank shaft bore.
5	Lay auxiliary drive bracket on engine rails and drill mounting holes	Holes properly located for mounting drive bracket.
6	Mount auxiliary drive bracket. Torque=250 ft-lbs	Auxiliary drive bracket mounted.
7	Install stub shaft with 4 bolts and washers. Torque=460 ft-lbs.	Stub shaft installed on engine.
8	Measure stub shaft dynamic run-out with dial indicator. Max=.005"	Confirm stub shaft is concentric with crankshaft.
9	Measure front face of damper run-out with dial indicator.	Confirm front face of damper flat.
10	Mount hub coupling and taper lock bushing onto stub shaft	Hub coupling installed.
11	Set bearing spacer plates and shims onto auxiliary drive mount	Bearing mounting will be close to parallel to stub shaft.
12	Build auxiliary drive shaft assembly	Shaft and bearings are assembled away from mount.
13	Lift auxiliary drive shaft assembly and place onto bracket	Entire auxiliary drive shaft assembly in place.
14	Torque all set screws on thrust collars and bearings.	Bearings mounted to verify shaft run-out.
15	Measure run-out of auxiliary shaft hubs. Max=.015"	Run-out on auxiliary drive shaft per tolerance.
16	Install radiator to engine rails	Radiator mounted to engine.
17	Loosen idler and install belts.	Drive belts installed.
18	Install coupling flex element. Torque=75 ft-lbs	Coupling installed correctly.
19	Tension drive belts. See Appendix II	Fan drive installed correctly.
20	Reinstall JW and AC pump flanges and bypass tube	Flanges installed for coolant pipes.
21	Belt guard and coupling guard installation	All safety provisions installed correctly.
22	Inspection required after moving engine and/or radiator	Additional steps required if engine or radiator are moved.

**Table 2: Auxiliary Drive Installation Summary**

**Step 1: Gather all required resources**

- Reference table 3 below. Before continuing, confirm ALL items in table are ON HAND and AVAILABLE. If not, **STOP** and gather resources.

Resources required for auxiliary drive install	
Item	Source
Auxiliary drive kit	IEA
Wishbone mounting kit	IEA
Auxiliary Mounting Kit Drawing	IEA
Wishbone mounting kit drawing	IEA
C175 Engine	Customer
Lifting mechanism for drive assembly	Customer
Lifting mechanism for radiator (likely crane)	Customer
Dial indicator	Customer
Torque wrench capable of 600 ft-lbs	Customer
Torque wrench capable of 100 ft-lbs	Customer
Torque wrench capable of 250 ft-lbs	Customer
Mag drill and bits for drilling .88" hole	Customer
Wire wheel or buffing pad for paint removal	Customer
Emory cloth for fan shaft	Customer
Anti-seize and thread lock (Loctite)	Customer
Hammer and 3/4" Drive Socket set	Customer
Socket sets w/1-5/16", 1-7/16" 6,12 pt sockets	Customer
Engine turning bar for C175	Customer
Belt Tension checker (frequency)	Customer

**Table 3: Resource requirements for Auxiliary Drive Installation**

**Step 2: Remove Jacket water (JW) and After cooler (AC) pump flanges and bypass tube off engine**

The JW and AC pump flanges and bypass tube will interfere with drilling holes into the engine rails. **Retain all parts and hardware.**

- Refer to Figure 1 above and remove JW and AC pump flanges. The bypass tube is attached to the JW flange.



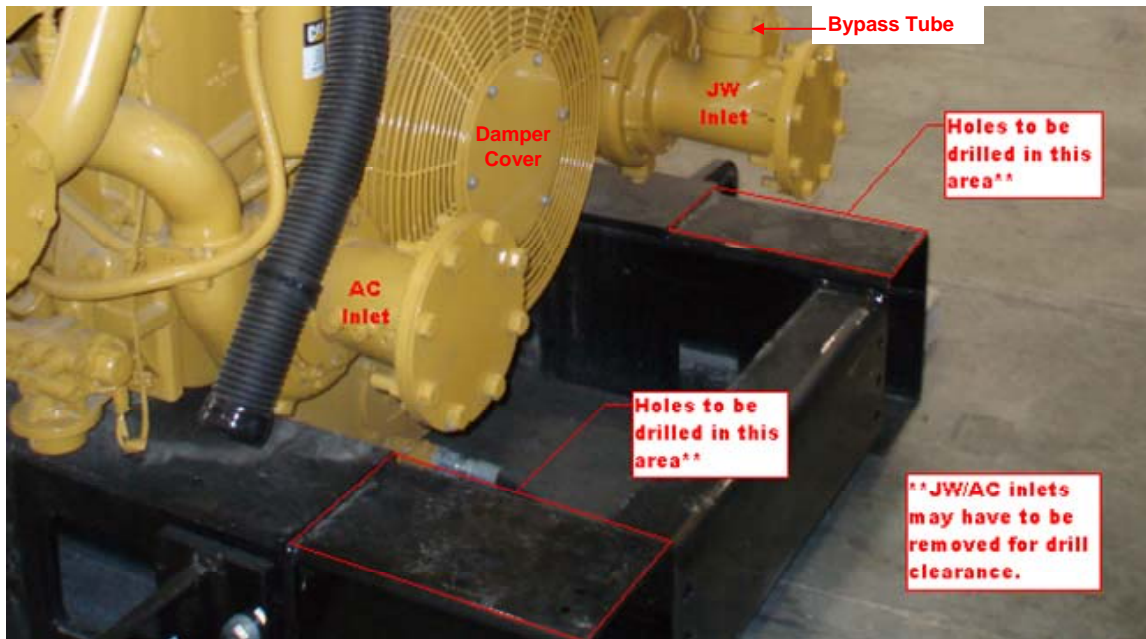

Figure 1: Front of C-175 Engine

**Step 3: Remove damper cover from engine**

- Use socket set to remove damper cover. This exposes the damper washer and crank shaft bore, to which the stub shaft mounts.

**Step 4: Remove paint from the ID of the damper bore and front face of the damper washer**

In order to ensure smooth stub shaft rotation, the paint must be removed from all stub shaft mounting surfaces.

- Using a wire wheel or buffing pad, remove paint from ID of the damper bore. Paint must be removed on entire damper washer ID. See Figure 5 for photo of required paint removal.
- Using a wire wheel or buffing pad, remove paint from front face of the damper washer. Paint shall be removed where the stub shaft bolts to the damper washer.

**⚠ WARNING:** Do not use a grinding wheel or similar tool. The goal is to remove PAINT ONLY, not to remove metal.

**Step 5: Lay auxiliary drive bracket on engine rails and mark holes**

- Refer to Auxiliary Drive assembly drawing provided during sales approval and lay bracket onto engine rails. If not available, contact IEA, LLC at phone number below for assistance.
- Mark 8 locations for mounting holes. Refer to Figure 2 below.
- Using mag drill or similar tool, drill all holes into engine rails. Refer to Auxiliary Drive assembly drawing for hole size.



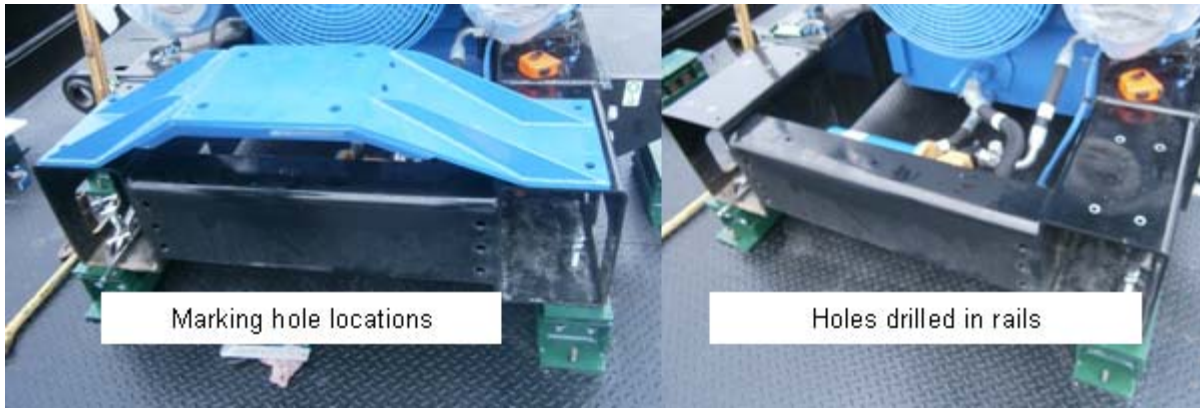

**Figure 2: Mounting auxiliary drive bracket**

**Step 6: Mount auxiliary drive bracket**

- Using supplied hardware, mount auxiliary drive bracket to engine rails.
- Torque all bolts to 250 ft-lbs.

**⚠ WARNING: The next two steps are the most crucial for ensuring coupling life. Failure to adhere to the tolerances listed WILL result in premature coupling failure, which is NOT covered by standard warranty.**

**Step 7: Install stub shaft onto damper**

- Using 4 bolts and washers, install stub shaft onto damper.
- Using 600 ft-lb torque wrench, torque bolts to 460 ft-lbs.
- Insert and tighten bolts in general order shown below. **Do not use impact wrench.**
  - Insert bolt and tighten to finger tight.
  - Next bolt inserted shall be the bolt on the OPPOSITE side of the stub shaft. Refer to Figure 3 below.
  - Repeat for all four bolts.
  - For proper torque, use torque wrench to torque bolts to approximately 250 ft-lbs. Torque bolts in order shown below.
  - Torque bolts to 350 ft-lbs. in order shown below.
  - Torque bolts to 460 ft-lbs, in order shown below.

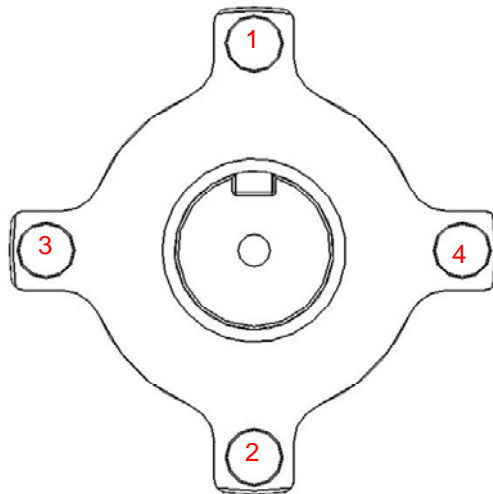

**Figure 3: Bolt insertion and tightening order**

### Step 8: Measure stub shaft run out with dial indicator

- Securely mount dial indicator to auxiliary drive bracket and set dial indicator to a location that can accurately dial indicate stub shaft. Refer to Figure 4.
- Using engine turning bar, turn engine crankshaft one complete revolution.
- Measure stub shaft run out. Maximum run out is .005". If run out is acceptable, go to step 10.
- If stub shaft run out is more than .005", remove then check for any paint chips and rotate stub shaft 90 degrees, remount stub shaft and measure dynamic run out again.
- If dynamic run out does not meet specification, continue to step 9.

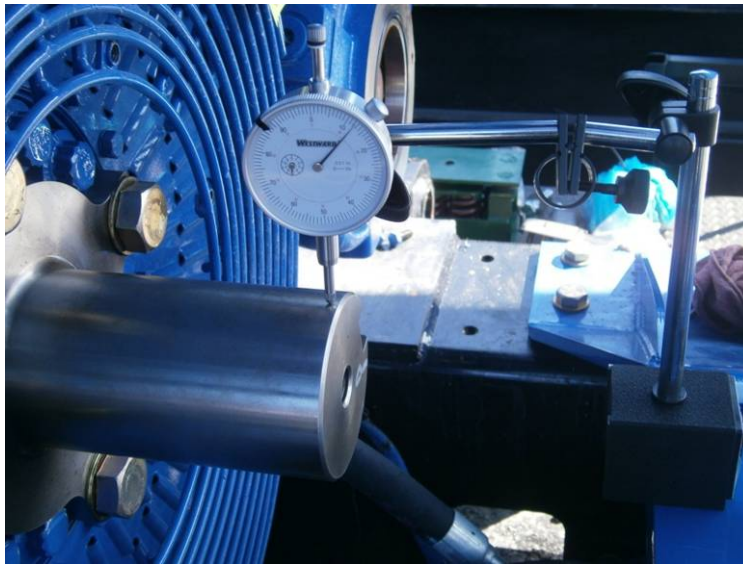
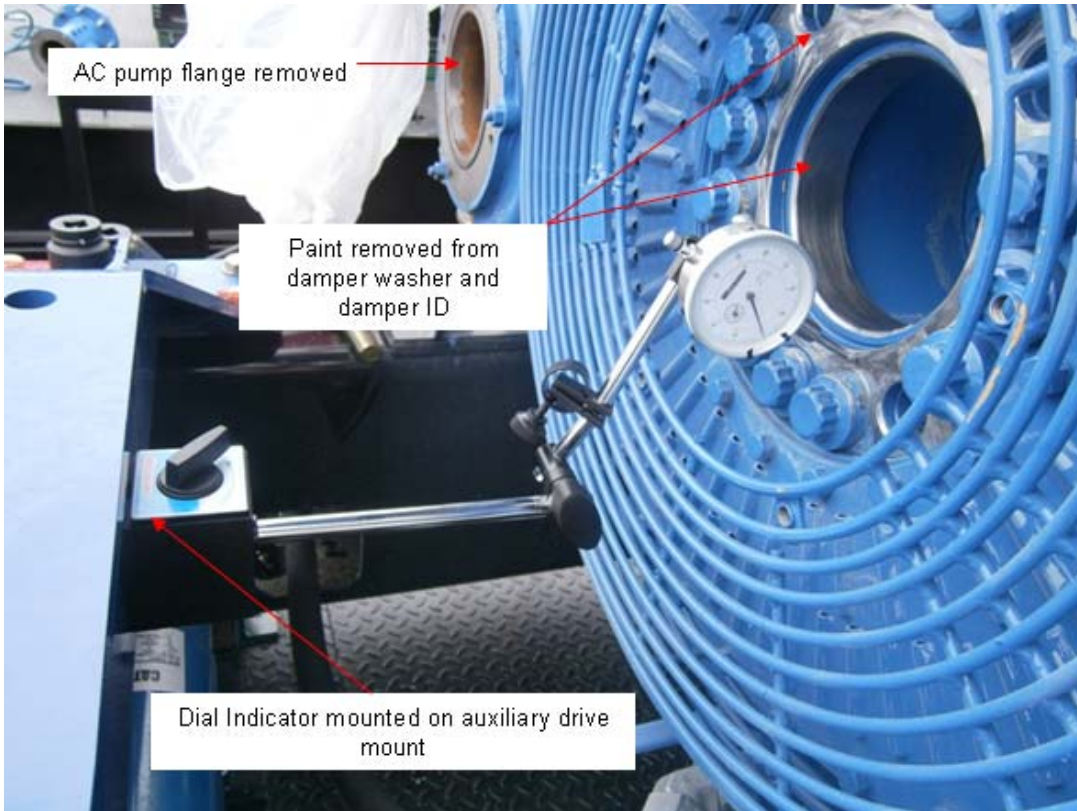

Figure 4: Dial indicator on stub shaft

**Step 9: Measure run out of front face of damper washer with dial indicator**

Dynamic run out is the radial distance that a shaft does NOT turn about its axis. Excessive dynamic run out shortens bearing and coupling life.

- Remove stub shaft.
- Mount dial indicator on auxiliary drive bracket. Refer to Figure 5.
- Using engine turning tool, rotate crankshaft one complete rotation.
- Read dial indicator, record your reading and then contact IEA's Service and Warranty Department to discuss next steps.

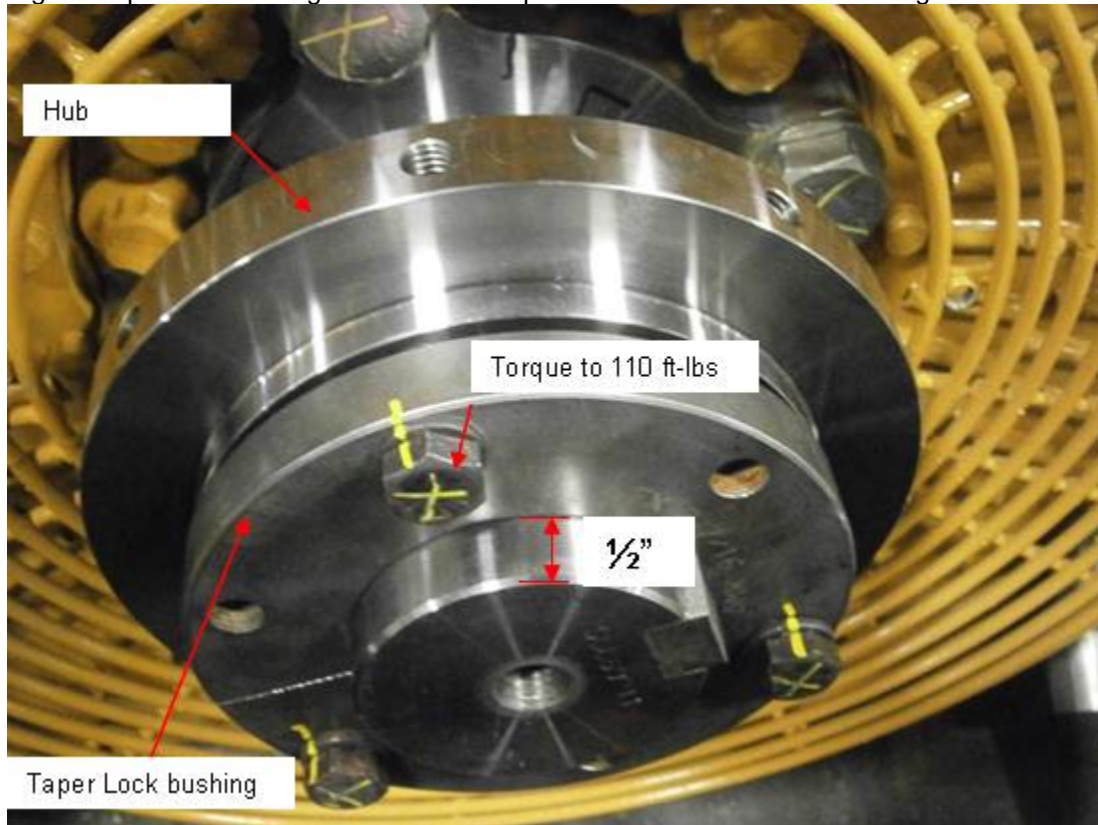

**Figure 5: Dial indicator on front face of damper washer**



**Step 10: Mount coupling hub and taper lock bushing to stub shaft**

- Install hub on stub shaft and place approximately 2" from end of stub shaft.
- Install taper lock bushing  $\frac{1}{2}$ " from end of stub shaft.
- Tighten taper lock bushing into hub and torque bolts to 110 ft-lbs. Refer to Figure 6.

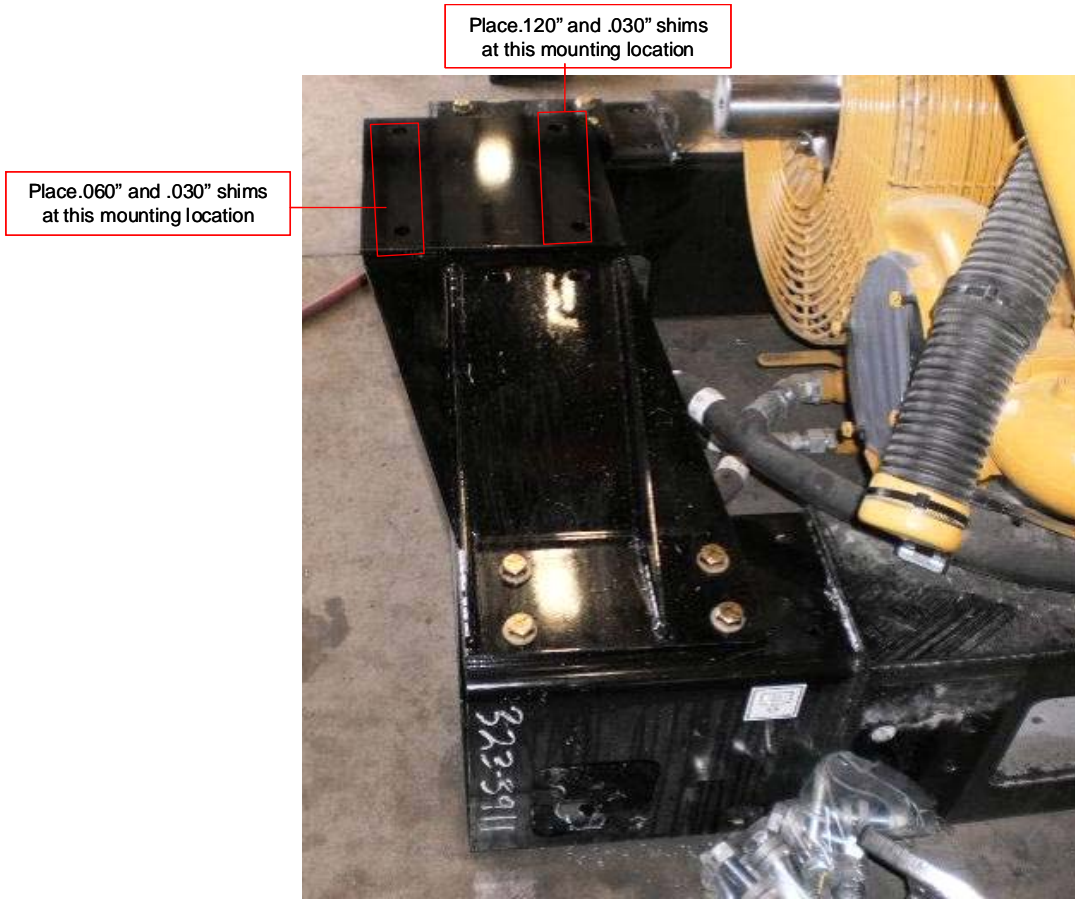

**Figure 6: Hub and taper lock bushing installed**

**Step 11: Set spacer plates and shims required**

The bearings, coupling and stub shaft must be properly aligned in all directions. Previous steps have ensured the stub shaft is mounted properly. The next steps ensure the drive bearings and driven sheave are installed properly. **The shims listed below are proven to be good starting points but must be confirmed later in the process.**

- Refer to auxiliary drive assembly drawing and place appropriate spacer plate on drive base.
- Place a .120" shim and .030" shim on the mounting holes closest to the engine.
- Place a .060" shim and .030" shim on the mounting holes away from the engine.
- Refer to Figure 7 below for further guidance.



**Figure 7: Bearing shim selection and locations**

## Step 12: Build auxiliary drive shaft assembly.

This step can be completed away from auxiliary drive bracket or on drive bracket. If radiator is not mounted, IEA, LLC recommends building on the drive bracket.

- Refer to Figure 8 below.
- Place auxiliary drive shaft through bearings, ensuring thrust collars are mounted **between** bearings.
- Bearings shall be placed so the mounting holes are 9" apart.
- Push thrust collars to bearings. Tighten set screws so drive shaft does not move.



**NOTE:** It is not necessary to torque set screws to specification at this time since the drive shaft will likely have to shift during final assembly.

- Place remaining hub onto drive shaft.
- Place taper lock bushing onto drive shaft end near the hub. Place taper lock bushing 1/2" from shaft end. Bolt taper lock bushing into the hub, torque to 110 ft-lbs.
- On opposite shaft end, place driver sheave and taper lock bushing. Taper lock bushing must be 2-1/8" from shaft end. Bolt taper lock bushing into driver sheave. Torque taper lock bushing bolts to 60 ft-lbs.

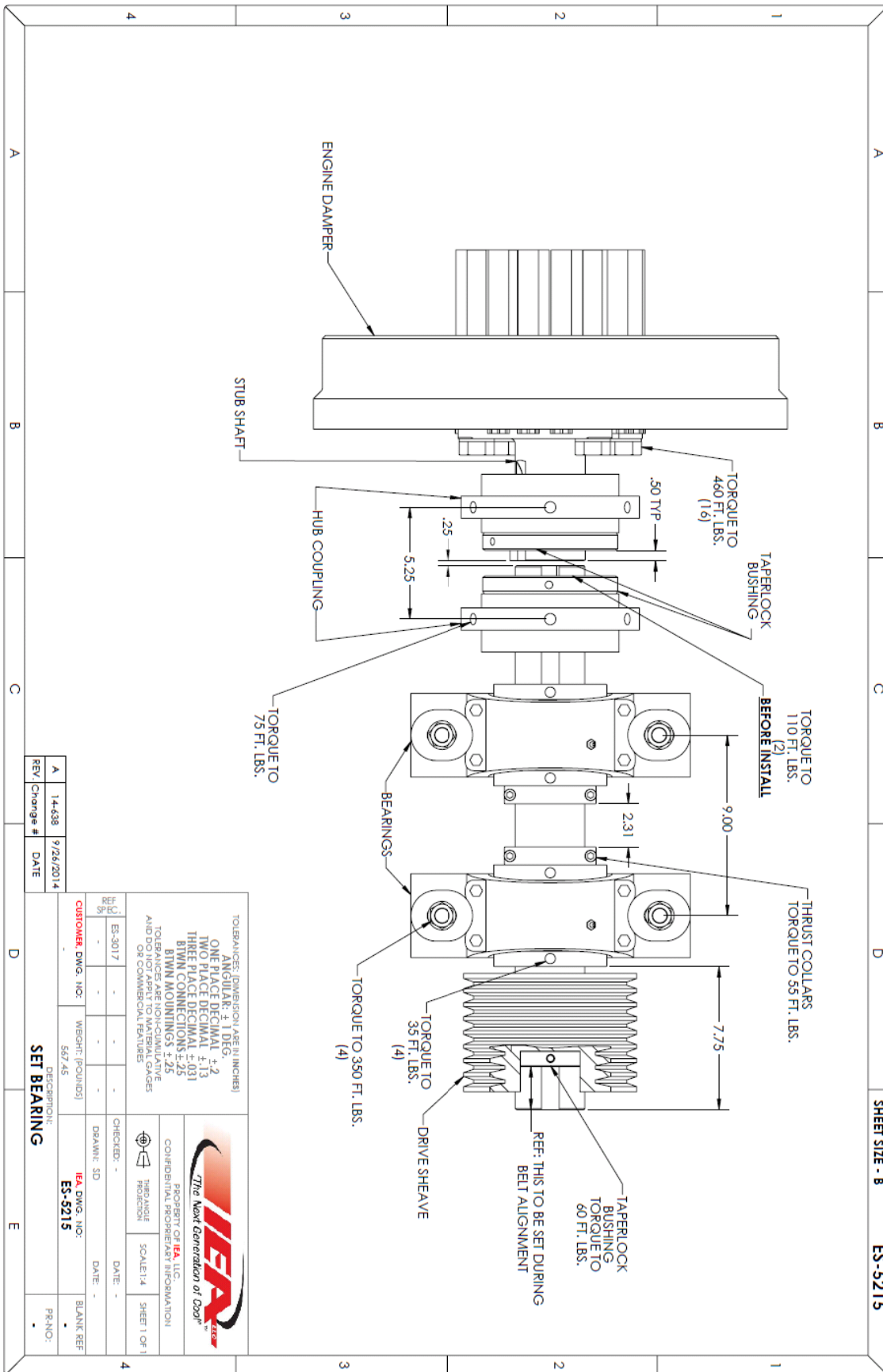
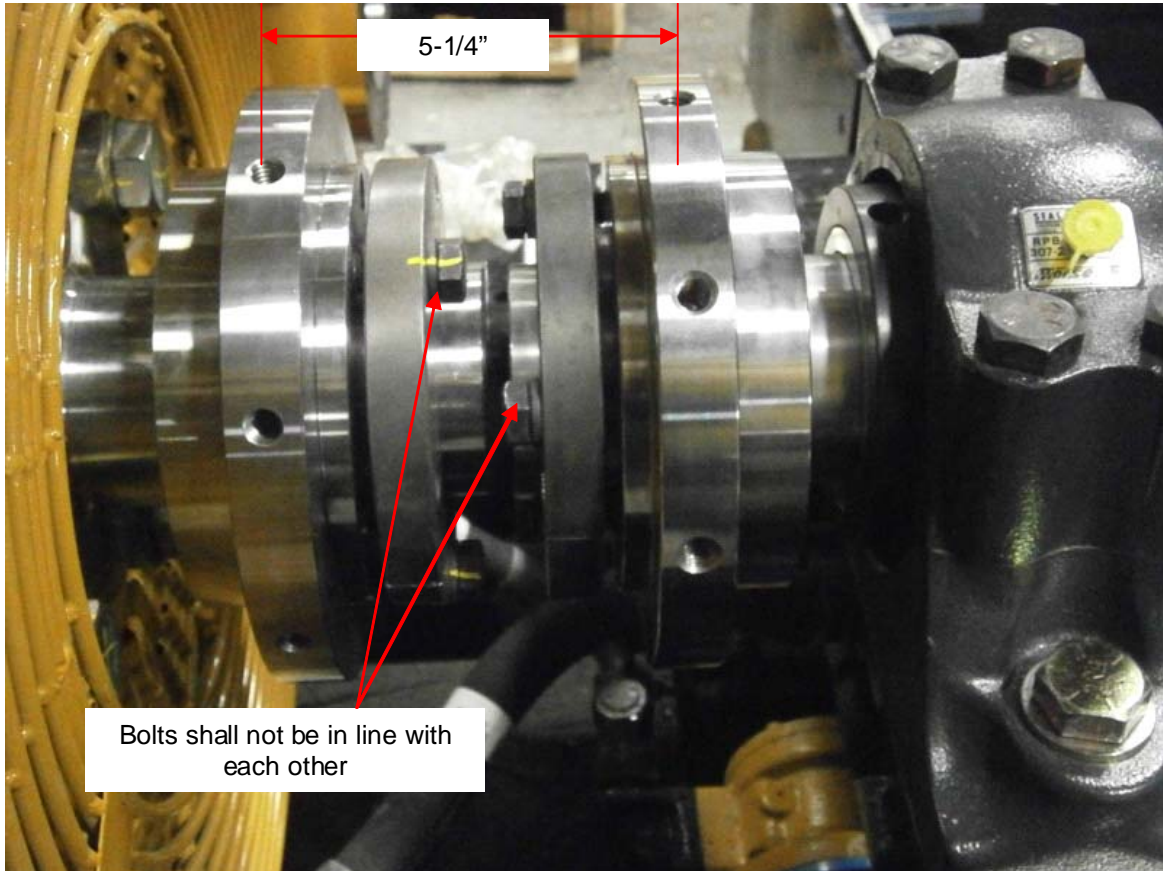

Figure 8: Drive and bearing assembly diagram



**Step 13: Lift auxiliary drive shaft assembly and place onto bracket**

- Using appropriate lifting provision (fork lift or hoist), lift drive and bearing assembly.
- ⚠ **WARNING:** If drive must be lifted, lift from the outside of each bearing (two points).
- Place assembly onto auxiliary drive bracket, placing bearings on shims and lining up bearing mounting holes to holes in drive bracket.
- Move auxiliary drive shaft as necessary so mounting holes in coupling hubs are 5-1/4" apart.
- Align hubs as close as possible in angular misalignment and parallel offset.
- Bolt bearings to bracket and torque to 350 ft-lbs.



**Figure 9: Hub spacing**

**Step 14: Torque all set screws on thrust collars and bearings**

- Tighten set screws on thrust collars to 55 ft-lbs.
  - Tighten set screws on bearings to 35 ft-lbs.
- 📌 **NOTE:** Rotate auxiliary drive shaft to look for set screws on bottom side of shaft.



### Step 15: Measure dynamic run out of hubs

Refer to Figures 10 and 11 for this step.

- Attach dial indicator to auxiliary shaft hub.

 **NOTE:** Figures 10 and 11 show dial indicator attached magnetically to auxiliary shaft hub. Clamping dial indicator to auxiliary shaft hub is acceptable.

- Rotate auxiliary shaft clockwise and counterclockwise to verify hub dynamic run out. Maximum hub dynamic run out is .015”.
- If hub dynamic run out is in excess of .015”, add or remove shims, or move bearings as necessary and torque bearing bolts again to bring dynamic run out into tolerance.

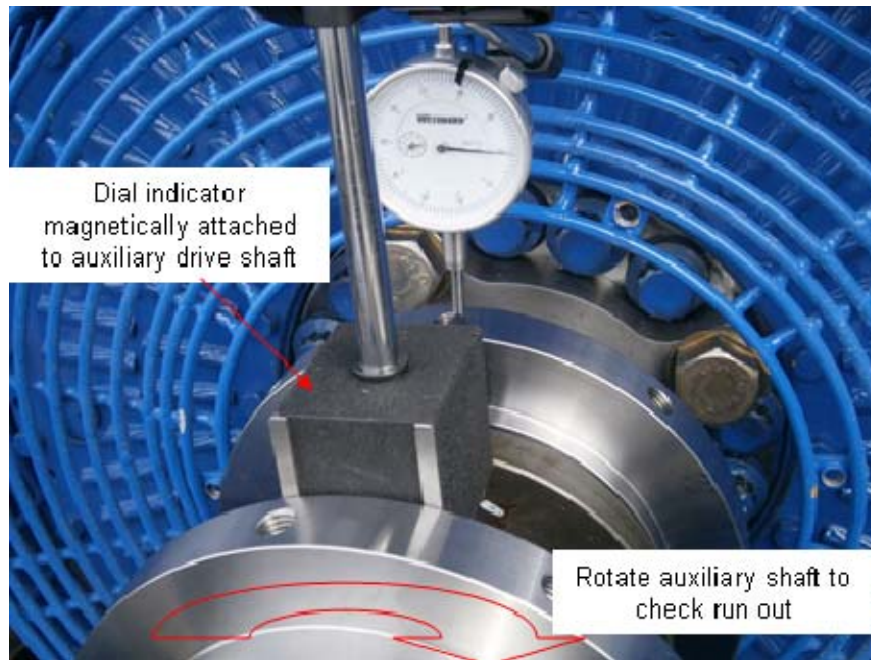

**Figure 10: Dial indicator for hub run out**

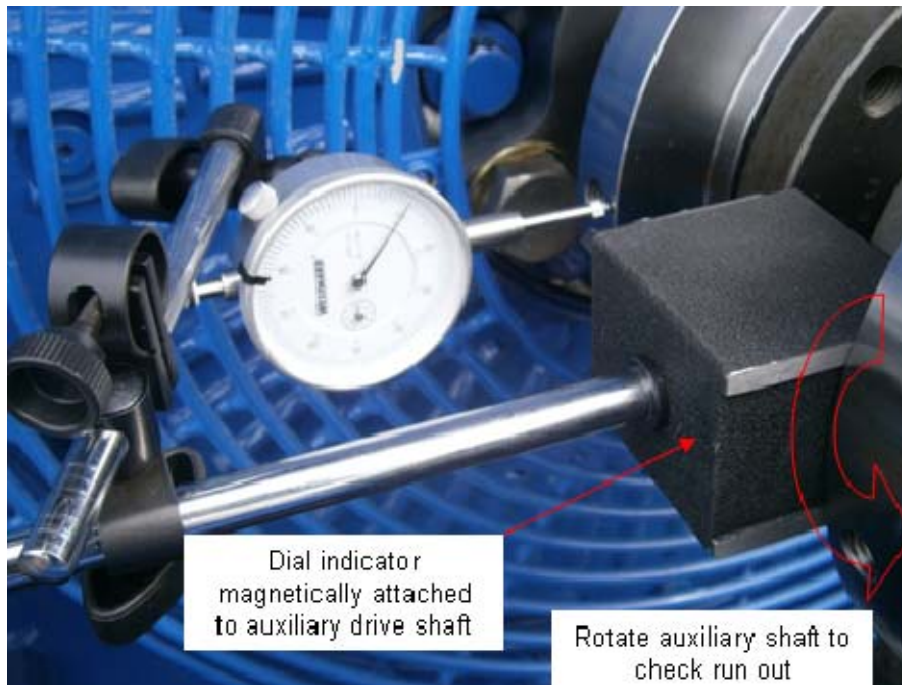

**Figure 11: Dial indicator for hub run out**

**Step 16: Install radiator to engine rails**

Refer to wishbone mounting kit drawing provided during initial sales approval. If not available, contact IEA at phone number below for drawing.

- Remove front lifting lugs from engine rail. **Retain lugs and mounting hardware, lugs will be installed after mounting radiator.**
- Remove front panel of belt guard.
- Lift radiator with appropriate lifting provision and place radiator per installation drawing.
- Install wishbone mounting kit per drawing.
- Reinstall lifting lugs.
- Figures 12 and 13 below show complete radiator mounting for reference.



Factory provided lifting lug

IEA provided hardware and bracket

Figure 12: Engine rail to wishbone interface (outside view)

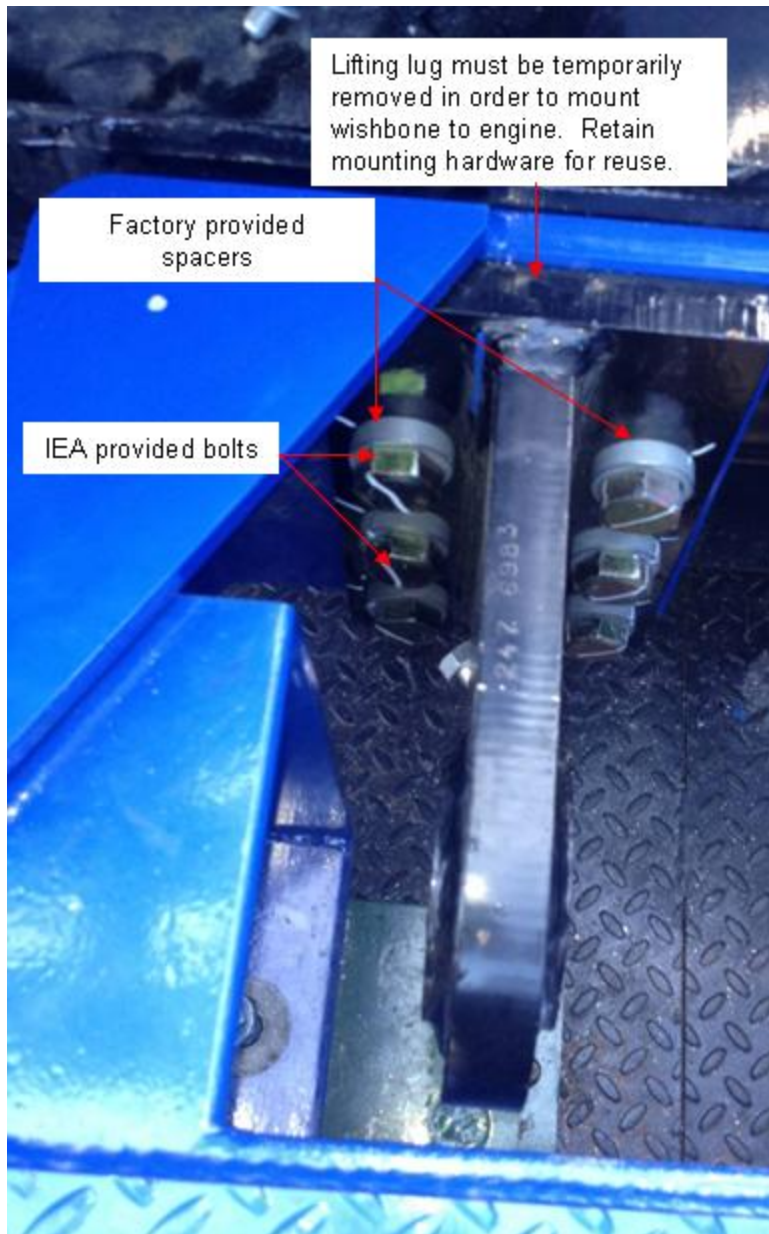

**Figure 13: Engine rail to wishbone interface (inside view)**

#### **Step 17: Loosen idler and install belts**

Refer to radiator Installation, Operation and Maintenance manual for guidance on installing belts and sheaves. Do **NOT** tension belts until flex coupling is installed.

#### **Step 18: Install coupling**

Refer to provided coupling literature for additional information. Coupling has two halves.

- Line up mounting holes on flex coupling to tapped holes in hub.
- Place coupling half on hubs.
- Bolt coupling to hubs using factory supplied bolts.
- Place second coupling half on hubs.
- After both coupling halves are installed, torque all bolts to 75 ft-lbs. Refer to Figure 14.





**Figure 14: Flexible coupling installed**

**Step 19: Tension drive belts**

Refer to radiator installation, operation and maintenance manual.

**Step 20: Reinstall JW and AC pump flanges and bypass tube**

- Install JW and AC pump flanges that were removed earlier. Torque bolts to CAT specification.

**Step 21: Belt guard and coupling guard installation**

- Install front cover of belt guard, torque bolts to 25 ft-lbs.
- Install coupling guard, torque bolts to 25 ft-lbs.
- Ensure all moving parts are clear of obstructions.
- Refer to Figure 15 below.



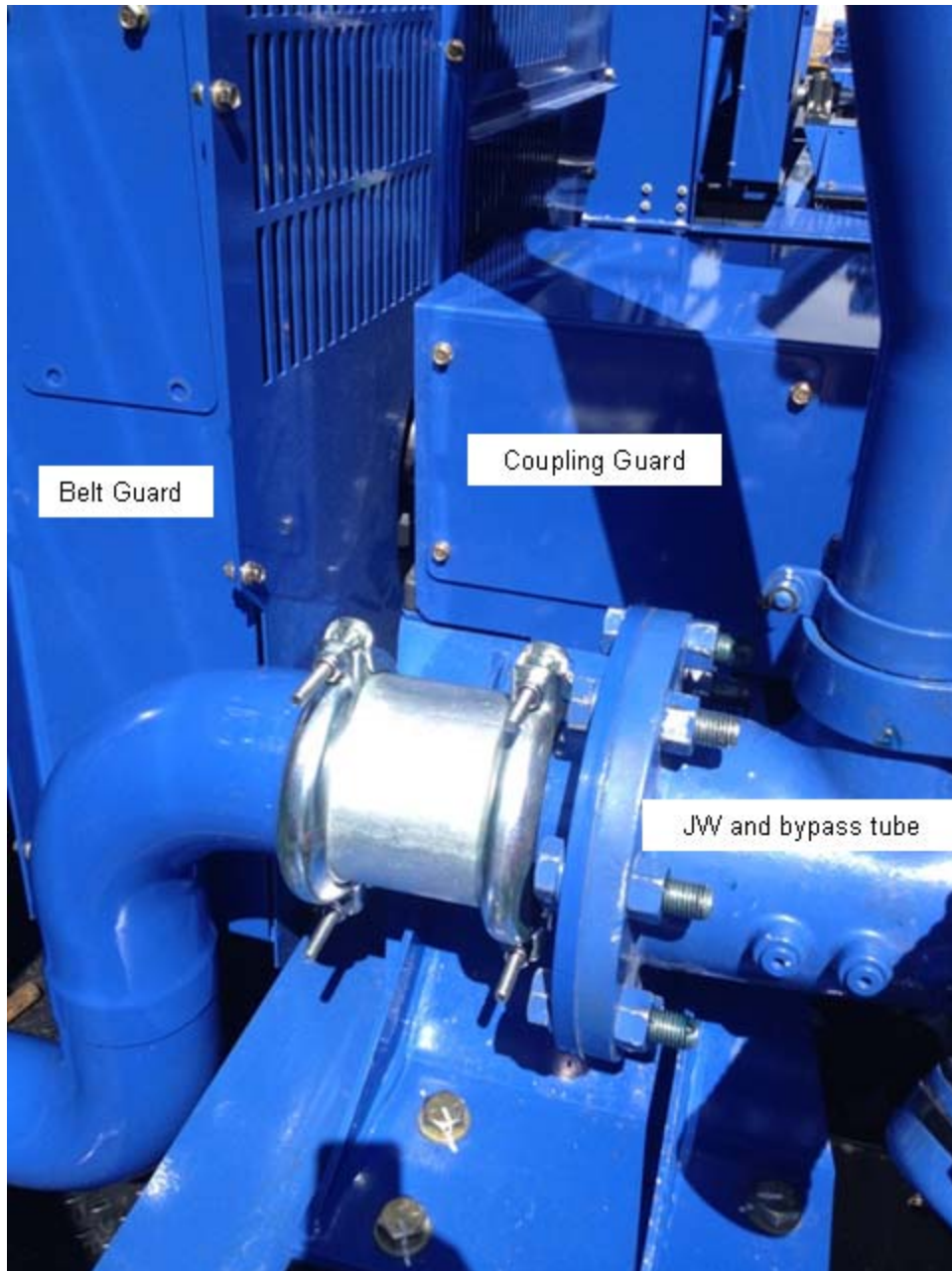

**Figure 15: Guards and connection kit installed**

**Step 22: Inspection required after moving engine and/or radiator**

If the engine and/or radiator are moved AFTER installing the coupling, the following **must** be done.

**If the unit has run more than one hour-the coupling MUST be reinstalled in the EXACT location as it was run.**

- Before moving the radiator, mark the location of the flexible coupling for reinstallation on original location on the hub.
- Remove flexible coupling.
- After moving the engine and reinstalling the radiator, measure hub coupling run out.(Refer to steps 14 and step 15).
- Reinstall coupling (Refer to Step 18).