

RCC | Remote Charge Cooler

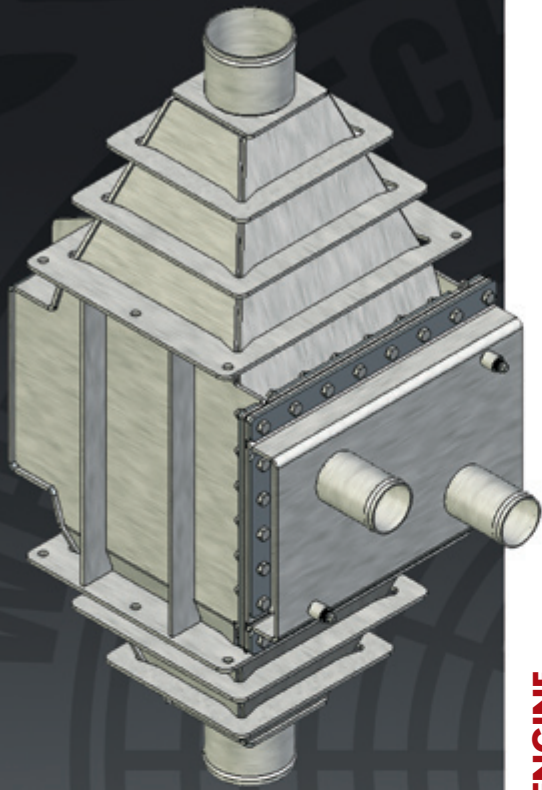





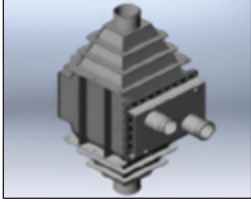
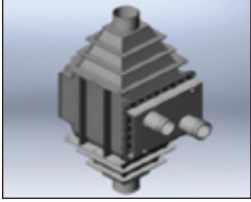

C18

C27 & C32

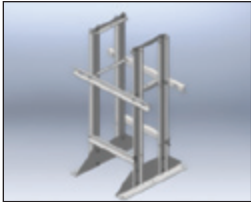
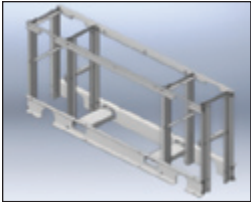
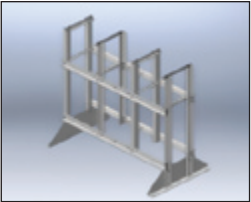
3516C

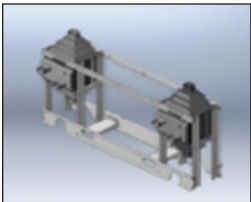
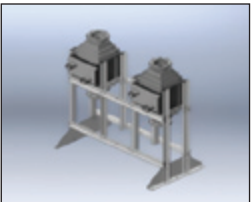
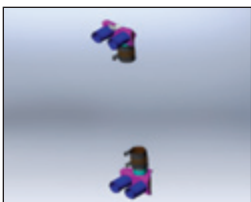
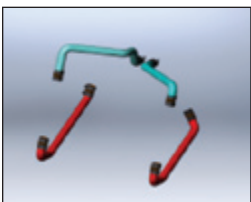
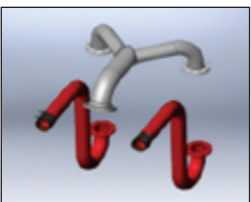
ENGINE

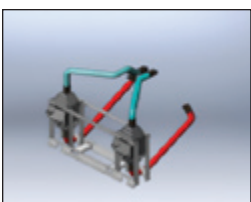
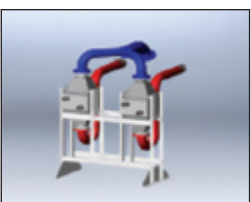
	C18	C27 & C32	3516C
RCC UNIT #	 RCC1001	 RCC1001 (2)-UNITS	 RCC1501 (2)-UNITS
FRAME #	 RCC1001FA	 RCC1002FA	 RCC1502FA
RCC & FRAME #	 RCC1001AFA	 RCC1002AFA	 RCC1502AFA
PIPE KIT #	 RCC1001PC1800	 RCC1002PC2732	 RCC1502P3516C
RCC, FA, PK	 RCC1001-C1800	 RCC1002-C2732	 RCC1502-3516C

Due to high temperatures in the units and the connection pipe kits, fully insulating these components to prevent injury is the responsibility of the end user



phone 262-942-1414 fax 262-942-1410 toll free 800-919-9559
web www.iearad.com email sales@iearad.com

Corporate Headquarters 9625 55th Street, Kenosha, WI 53144